

DT9837

High Performance USB Module for Sound & Vibration Analysis

DT9837

Type: Noise & Vibration Analysis Bus: USB

Key Features

- **4 simultaneous, 24-bit A/D channels** for high resolution measurements.
- **Support for four IEPE inputs**, including 4mA current source.
- **Portable operation.** No external power supply needed. Runs on USB power.
- **Tachometer input support** in the A/D data stream for synchronizing measurements..
- **Sampling rate of over 52kHz** to meet your application need.
- **Low frequency measurements** supported with a wide pass band of 0.5Hz to 25.8kHz (0.49 x sampling frequency).
- **Analog input ranges of ±10V and ±1V** with software-selectable gains of 1 and 10
- **One 24-bit Delta-Sigma D/A converter** with single-value or ultra-smooth waveform capability.
- **Programmable triggers for analog input operations** for maximum flexibility. Choose a software trigger, TTL trigger, or analog threshold trigger.
- **Software selectable AC or DC coupling.**
- **Supported by all DT-Open Layers for .NET Class Library** compliant software to meet any application need.



Figure 1. The DT9837 has 4 simultaneous IEPE sensor inputs plus a synchronous tachometer input and is ideal for portable noise and vibration measurement applications.

Summary of Features

A/D Throughput per Channel	D/A Channels	Tachometer Input	Simultaneous Subsystem Operation	Applications
52.734kHz 4 IEPE Inputs Simultaneous	1 Waveform or Single Value	1 Synchronous to Analog Data Stream	Yes	Vibration, Acoustics, Sonar

Overview

The DT9837 is a highly accurate five channel data acquisition module that is ideal for portable noise and vibration measurements. Four 24-bit IEPE (ICP) sensor inputs are synchronized with a tachometer input to provide data streams that are matched in time for field or lab use.

The 38 segment clock-time conversion of the Delta-Sigma A/Ds is offset in software to provide this time correlated data. The rugged small module is self-powered via the USB connection to a PC laptop. BNC connections are provided for all I/O signals for secure and easy-to-use operation.

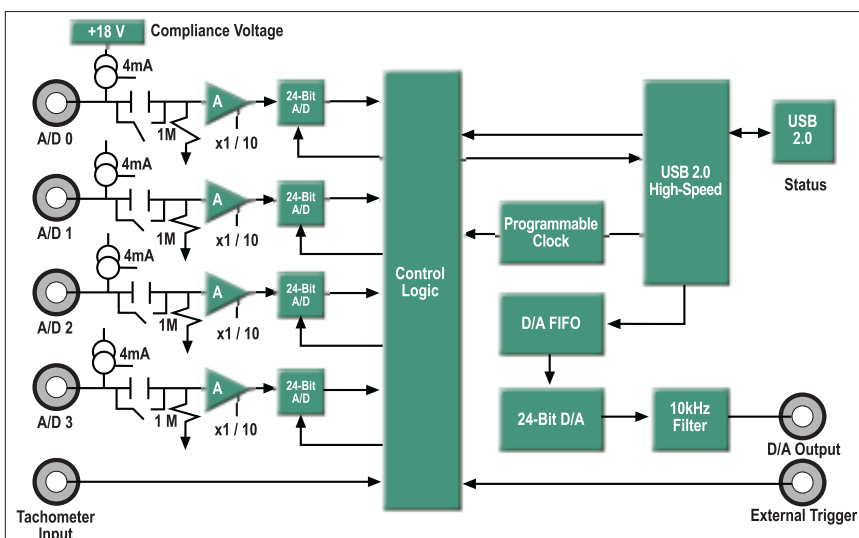

Figure 2. The DT9837 is a high performance, multifunction data acquisition module for USB that provides A/Ds with IEPE capability, one waveform D/A, a tachometer input, and simultaneous operation of all subsystems.

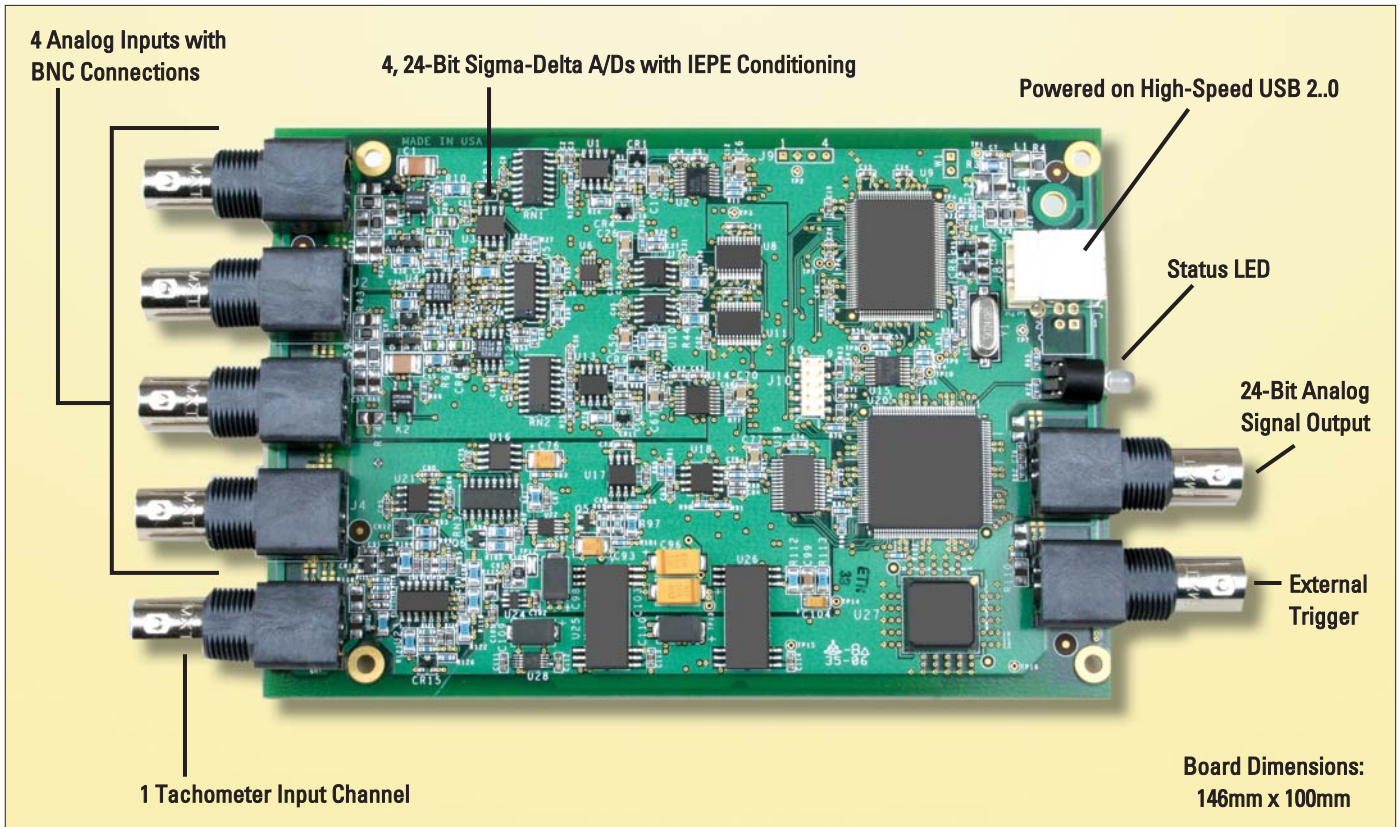

Figure 3. An OEM, board-level version of the DT9837 is available (DT9837-OEM). The DT9837 and the DT9837-OEM provide BNC connectors for easy signal connections.

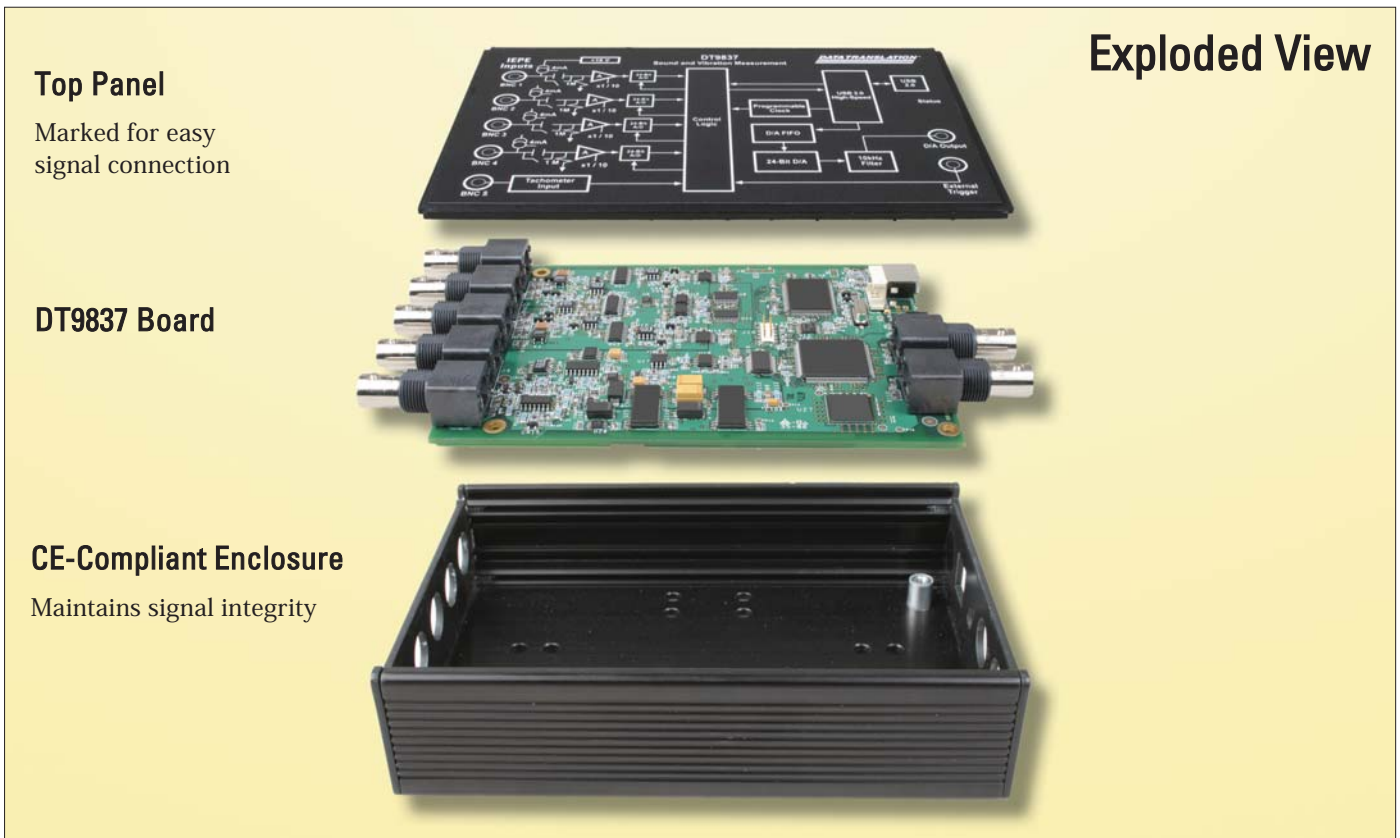

Figure 4. The DT9837 board is encased in a rugged, metal enclosure to ensure CE-compliance and maintain signal integrity.

Analog Inputs

The DT9837 module supports four analog input channels and a tachometer input. Gains of 1 and 10 are supported for effective input ranges of $\pm 10V$ and $\pm 1V$. The module uses 24-bit Delta-Sigma analog-to-digital converters (ADCs) that provide anti-aliasing filters based on the clock rate. These filters eliminate aliasing, which is a condition where high frequency input components erroneously appear as lower frequencies after sampling.

You can read data from one or more analog input channels using an analog input channel list. You can enter up to 5 entries in the channel list, including four analog input channels and the tachometer input.

Analog Inputs with IEPE Functions

Applications requiring accelerometers, vibration, noise, and sonar measurements often use IEPE sensors. The DT9837 module supports the following software programmable IEPE functions for each of its four analog inputs:

- Current source – Enable or disable the use of a 4mA current source to drive the IEPE sensors.
- AC/DC coupling – Select whether AC coupling or DC coupling is used.

Break detection is provided if using DC coupling with the 4mA excitation current source and the voltage input is positive, full-scale.

Delta-Sigma A/D Converters

These modules have built-in anti-aliasing filters for superior AC performance in noise and vibration testing applications.

Internally, the DT9837 module uses a Delta-Sigma converter for each analog input. Delta-Sigma converters offer the following advantages for analog input operations, making them ideal for noise and vibration testing applications.

- Reduce noise and improve accuracy by oversampling each input.
- Eliminate errors that result from aliasing and high frequency noise.
- Provide excellent low-level signal-to-noise performance, which improves dynamic accuracy on low-level signals.

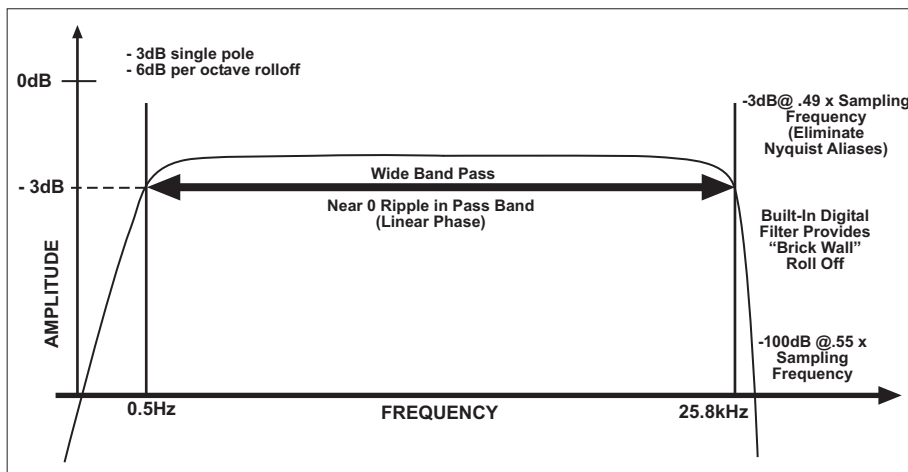

Simultaneous A/D Up to 52.734 kHz per Channel

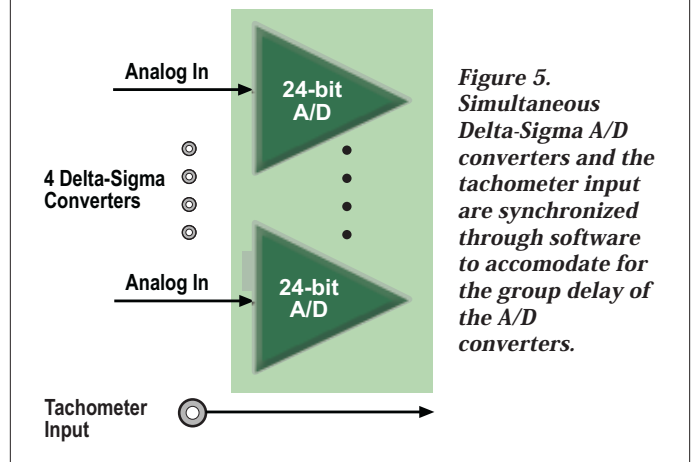

Figure 5. Simultaneous Delta-Sigma A/D converters and the tachometer input are synchronized through software to accommodate for the group delay of the A/D converters.

- Provide excellent differential linearity, which ensures consistently accurate data conversion across the full input range.

Group Delay and Data Synchronization

Because of the inherent filtering algorithms, Delta-Sigma converters have an initial delay of 38 clock pulses after the sample clock is first started and before the first conversion is completed, due to the group delay of converters.

The tachometer data (which does not have the 38 sample group delay) is synchronized with the analog data stream. This is done through the firmware and device driver by caching the tachometer data and aligning it in time with the analog data in the user's data buffers.

Tachometer Input

The DT9837 includes support for a tachometer input in the analog input data stream for synchronous measurements. The measurement edge for the tachometer input is rising. The module accepts one $\pm 30V$, 31-bit tachometer input signal with a maximum frequency of 380kHz and a minimum pulse width of 1.3 microseconds. The threshold voltage is fixed at $\pm 2V$ with 0.5V of hysteresis.

Measurements are based on two consecutive rising edges of the tachometer input signals.

The tachometer input is treated like any other channel in the analog input channel list; therefore, all the clocking, triggering, and conversion modes supported for analog input channels are supported for the tachometer input.

Figure 6. The DT9837 provides software selectable AC and DC coupling. When AC coupling is selected, the modules provide zero ripple in the wide pass band and excellent "brick wall" anti-alias filters eliminating unwanted high frequency interference.

Waveform Quality Analog Output

The DT9837 supports one 24-bit D/A converter with an output range of $\pm 10V$. You can output a single value from the analog output channel, or you can use a software trigger to start a waveform operation. A two-pole, 10kHz Butterworth filter is applied to remove clocking noise and smooth signal output.

A standard waveform such as a sine, triangle, or square wave is easily produced by loading the onboard FIFO with 8,192 samples. The specific waveform is output at a fixed rate of 46.875 kHz. Great care has been used in design to minimize the glitch energy for any major or minor carry. This results in extremely smooth waveforms.

You can update the analog output channel as you are acquiring analog input data for gap-free simultaneous stimulus and response. Note that since the module uses a Delta-Sigma D/A converter, 34 clock pulses are required before the first D/A conversion is complete.

Multiple Module Synchronization for High Channel Count Applications

The internal clock on the DT9837 module, which is derived from the USB clock, provides the timing for both the analog input and analog output subsystems on the module. You can synchronize the start of acquisition on multiple modules by connecting all modules to a shared external trigger input (Figure 7). When triggered, the modules remain locked to within one A/D conversion of the clock.

There are five trigger options when using multiple modules:

- Single module
 - Digital trigger
 - Analog threshold trigger
 - Software trigger
- Multiple modules
 - Digital trigger
 - Software trigger (uses one DAC output)

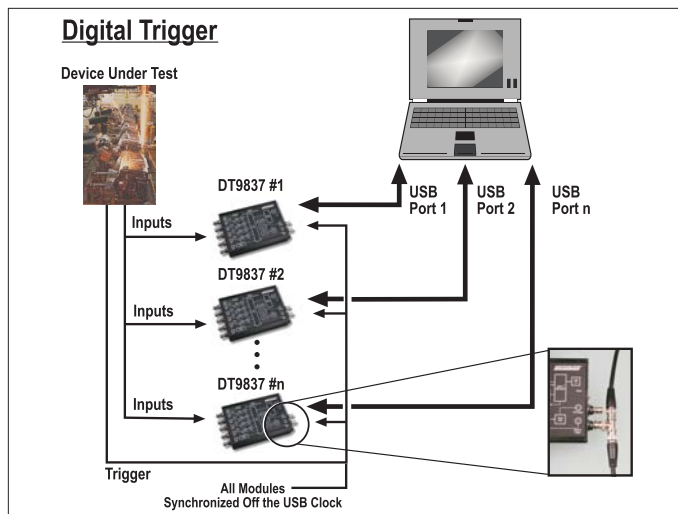

Figure 7. Multiple DT9837 modules can be triggered simultaneously by connecting all modules to a shared external trigger input.

Synchronous Operation

The DT9837 supports synchronous analog input, tachometer input, and analog output operations. Data is streamed synchronously to host memory. The synchronous operation allows all I/O data to be processed and correlated for all inputs and outputs. This is very valuable in determining the response across a device-under-test (DUT) to stimuli at the same exact instant.

Programmable Triggers

You can start an analog input operation using either a software trigger, external TTL trigger, or analog threshold trigger. Analog output operations start using a software trigger only. Using the internal trigger, I/O operations start based on a software command. Using an external trigger, analog input operations start when the module detects a low-to-high transition on the EXT TRIG (TTL) input of the module. Using an analog threshold trigger, analog input operations start when the module detects a signal on analog input channel 0 that rises above 1.0V.

Programmable A/D Clock

The DT9837 module supports an internal A/D clock with a maximum time base of 27MHz. Using software, you can specify the frequency (from 195.3Hz to 52.734kHz) at which to sample all the input channels.

The value that you specify for the internal clock frequency is multiplied by 512 internally to set the oscillator on the module. For example, if you specify an internal clock frequency of 50kHz, the module sets the internal oscillators for the A/D converters to 25.6MHz.

To eliminate aliasing, the DT9837 and supports a wide pass band of 0.5Hz to 25.8kHz (0.49 x the sampling frequency), allowing you to measure low frequency signals accurately at the Nyquist sampling rate.

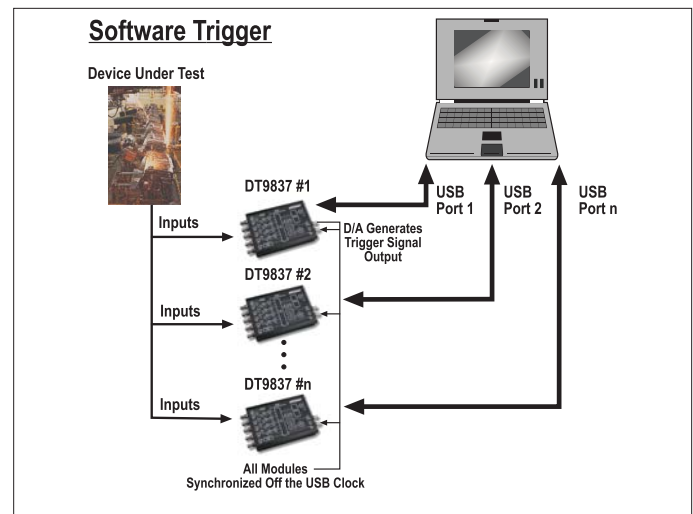

Figure 8. Using a software call to generate a trigger signal on one D/A output tied to all external trigger lines synchronizes the start of conversion for all modules.

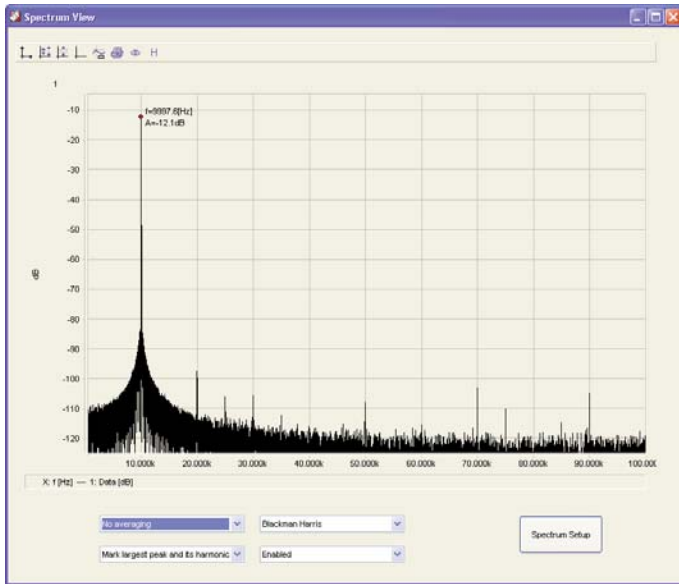

Figure 9. Measure Foundry allows you to create noise and vibration applications quickly and easily using a drag and drop graphical interface. No programming required.

Software

There are many software choices available for application development with the DT9837. Each option offers development capability at different levels. Choose from ready-to-measure applications to full graphical programming with Measure Foundry.

Measure Foundry

Measure Foundry is a powerful visual software environment for creating test and measurement, control, and analysis applications. It provides all the power and flexibility of a programming language in a drag and drop graphical interface. No programming or wiring is required!

Measure Foundry features include:

- **Create noise and vibration applications** quickly and easily.
- **Spectrum analyzer panel** allows you to display and analyze the frequency spectrum of an input signal.
- **Perform an FFT**, auto-correlation, or power spectrum on the input signal.
- **Store the data** to either an ASCII data file or a high performance .DCF file.
- **Provides several window functions:** Rectangle, Hanning, Hamming, Hann, Blackman, Blackman Harris 67db or 92 db.
- **Provides digital filter functions** including Bessel, Butterworth, Chebyshev, and Elliptic.

Other Software Choices

The DT9837 module ships with the Omni CD that includes the following software:

- **DT-Open Layers for .NET:** The DT-Open Layers for .NET Class Library is a collection of classes, methods, properties, and events that provides a programming interface for DT-Open Layers-compatible hardware devices. It can be used from any language that conforms to the Common Language Specification (CLS), including Visual Basic® .NET, Visual C#®, Visual C++® .NET with managed extensions, and Visual J#® .NET.
- **DT-Display for .NET:** DT-Display for .NET is a control for plotting data to a Windows form. It provides a powerful and user-friendly interface for rendering data.
- **DT-Open Layers for Win32:** DT-Open Layers for Win32 consists of the DataAcq SDK.
 - The **DataAcq SDK** consists of the necessary header files, libraries, example programs, and documentation to develop your own DT-Open Layers data acquisition and control applications. It is intended for use with non .NET languages, such as ANSI C, Visual C++ 6.0, and Visual Basic 6.0.
- **Drivers:** The 32-bit WDM device drivers make your application cross-platform compatible. These drivers support Data Translation USB and PCI boards using Windows® 2000/XP/Vista.

You can choose to install demo versions of the following software from the CD:

- **Measure Foundry** is an open, powerful application builder for test and measurement systems. No programming is required!
- **quickDAQ** is a high-performance, ready-to-run application that lets you acquire, plot, analyze, and save data to disk at up to 2 MHz per channel without writing any code. quickDAQ supports applications from temperature measurement to high-speed testing and analysis.
- **LV-Link** contains all necessary VIs, examples, and documentation to use Data Translation hardware in LabVIEW™ 8.0 and higher.

The following software is available as a free download from our website:

- **DAQ Adaptor for MATLAB** to access the visualization and analysis capabilities of MATLAB® from The MathWorks™.

The DT9837 is also supported by third-party noise and vibration analysis applications.

USB 2.0 Compatibility

The DT9837 module uses a high-speed USB 2.0 interface, which provides transfer rates between the module and the host at up to 480 Mbits/s. This means that all acquired signals stream to and from the host at full acquisition speeds. The DT9837 can also be used with USB 1.1 ports, but at USB 1.1 performance (12 Mbits/s).

Easy Signal Connections

The DT9837 provides BNCs for the analog input, tachometer input, analog output, and external trigger signals.

EMI and ESD Design Criteria

The DT9837 has been designed to perform with the lowest noise characteristics. Damping resistors in series with every I/O line minimize ringing and EMI and provide current limits that protect against transient signals.

Cross-Series Compatibility

Virtually all Data Translation data acquisition boards, including the DT9837, are compatible with the DT-Open Layers for .NET Class Library. This means that if your application was developed with one of Data Translation's software products, you can easily upgrade to a new Data Translation board. Little or no reprogramming is needed.

User Manual

Each data acquisition module includes a comprehensive user's manual. The manual is provided in electronic (PDF) format on the Data Acquisition Omni CD provided with the module. A hard copy manual is available for an additional charge.

Technical Support

Application engineers are available by phone and email during normal business hours to discuss your application requirements. Extensive product information, including drivers, example code, pinouts, a searchable Knowledge Base, and much more, is available 24 hours a day on our web site at www.datatranslation.com.

For more information about the DT9837, please visit:
<http://www.datatranslation.com/go/DT9837/>

Ordering Summary

- **DT9837** – High performance USB module for sound and vibration analysis; Packaged in CE-compliant enclosure.
- **DT9837-OEM** – Board-level version of the DT9837.

Software:

The following software can be purchased separately:

- **Measure Foundry** – Test and measurement application builder for Windows® XP/Vista. SP1300-CD.
- **quickDAQ** – High-performance, ready-to-run application that lets you acquire, plot, analyze, and save data to disk at up to 2 MHz per channel. SP8501-CD
- **LV-Link** – Access the power of Data Translation boards through LabVIEW™.

Free Software Downloads:

The following software is available as a free download from our website:

- **DAQ Adaptor for MATLAB** – Access the analyzation and visualization tools of MATLAB®.

All Data Translation hardware products are covered by a 1-year warranty. For pricing information, see the current price list, visit our website, or contact your local reseller.