

IDM-122/122RT

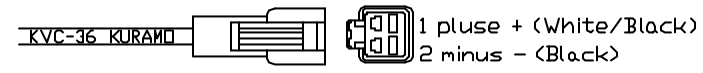

Details of Connector



	Light	Power Supply
Connector	SMR-02V-B	SMP-02V-BC
Contact	BYM-001T-0.6	BHF-001T-0.8SS

- * 576 Red Chip LEDs
- * Only 12V USE
- * Electric Power Consumption 23.1W

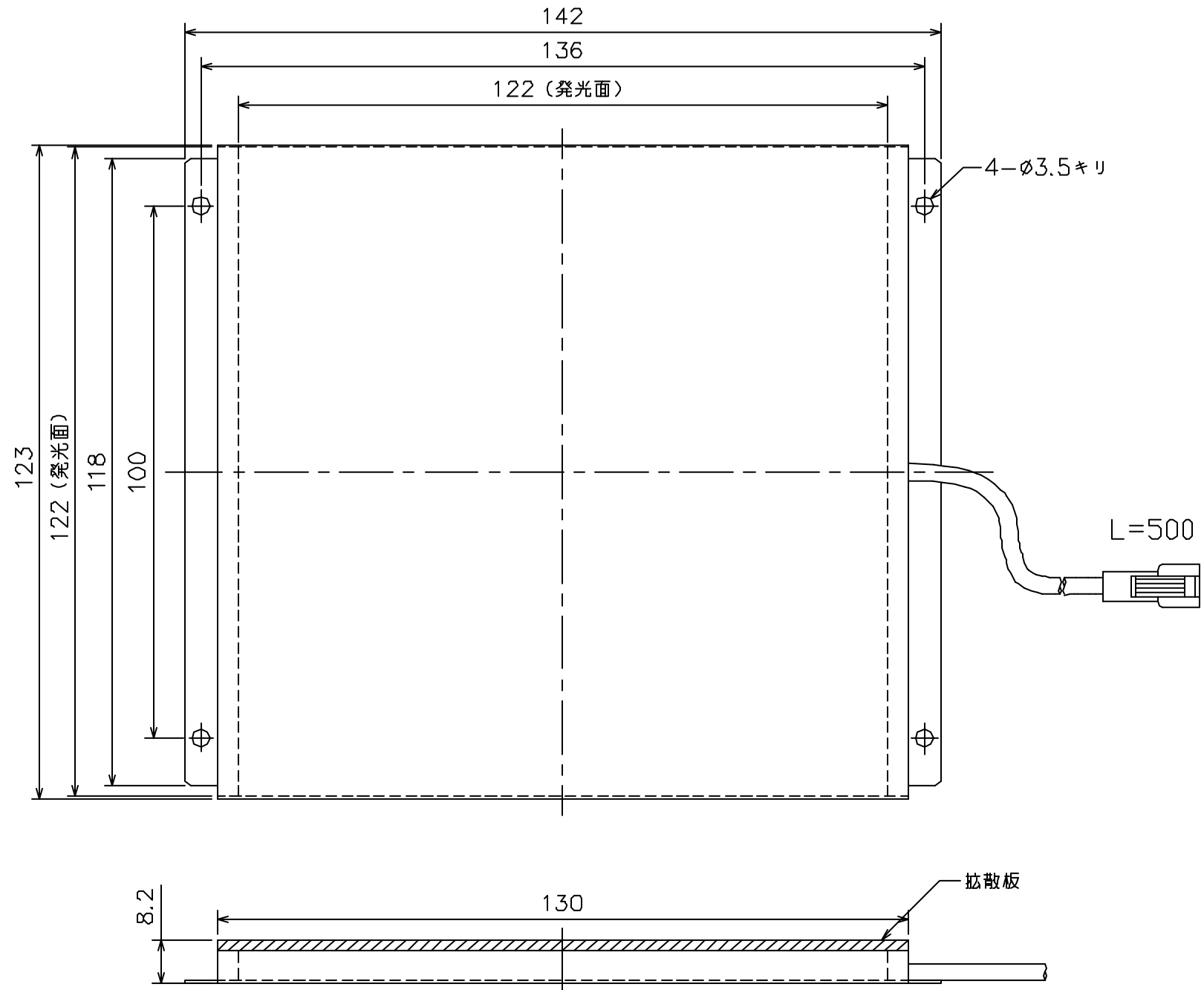

承 認	作 成

321-391