

品番	品名	材料	個數	記事
----	----	----	----	----

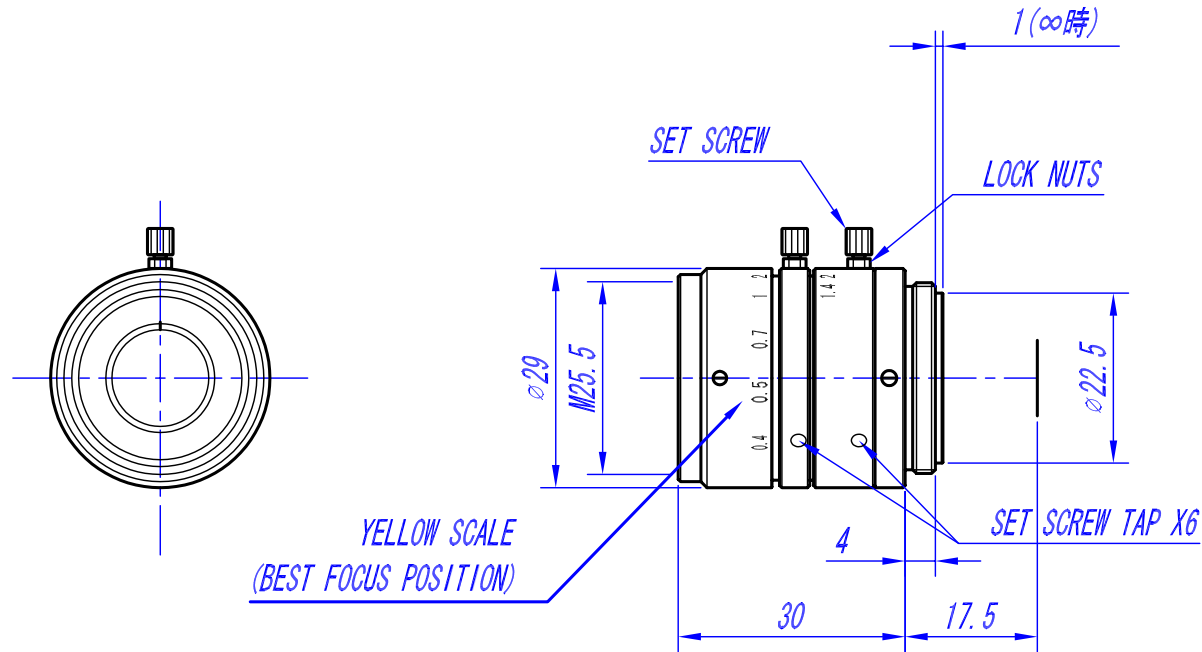

△				APPROVED	CHECKED	MATERIAL 材料				FINISH/ROUGHNESS 仕上程度				HEAT TREATMENT 熱処理		SURFACE TREATMENT 表面処理		QUANTITY 個數
△																		
△						OVER 250 UP TO 1000	±0.3	±0.5	±1.0	±0.2	UNIT (mm)	ANGLE 角度	METHOD 図法	REMARK 適用 (機種名)				
△				DESIGNED	DRAWN	OVER 63 UP TO 250	±0.2	±0.3	±0.6	±0.15				SV-M1614				
△						OVER 16 UP TO 63	±0.1	±0.2	±0.4	±0.1		SCALE	1/1	NAME	外觀圖			
△					T. M.	OVER 0 UP TO 16	±0.05	±0.1	±0.2	±0.1	DATE	'02.08.22	DRAW NO.	01D SV 0013A 1				
	DATE	EXCH NO.	REVISION 変更記事			TOLERANCES	A	B	C	S								