

品番	品名	材料	個数	記事
----	----	----	----	----

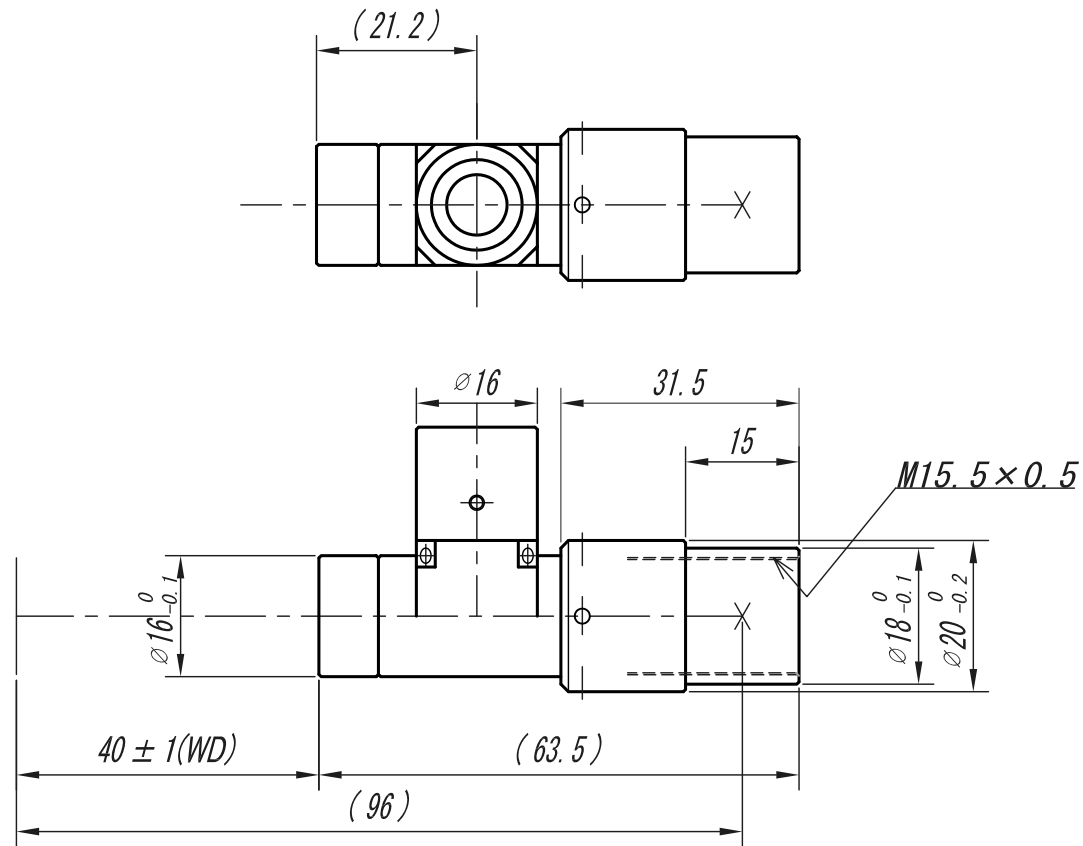

△				APPROVED	CHECKED	MATERIAL 材料				FINISH/ROUGHNESS 仕上程度				HEAT TREATMENT 熱処理		SURFACE TREATMENT 表面処理		QUANTITY 個数
△				J. A.	T. A.													
△				DESIGNED	DRAWN	OVER 250 UP TO 1000	±0.3	±0.5	±1.0	±0.2	UNIT (mm)	ANGLE 角度	METHOD 図法	REMARK 適用 (機種名)				
△						OVER 63 UP TO 250	±0.2	±0.3	±0.6	±0.15				VS-TC2-40COM				
△				T. T.	T. M.	OVER 16 UP TO 63	±0.1	±0.2	±0.4	±0.1		SCALE	1 / 1	NAME	外觀図			
	DATE	EXCH NO.	REVISION 変更記事			TOLERANCES	A	B	C	S	DATE	'03.08.10	DRAW NO.	ODTC0060A1				